

WORKPIECE CARRIERS

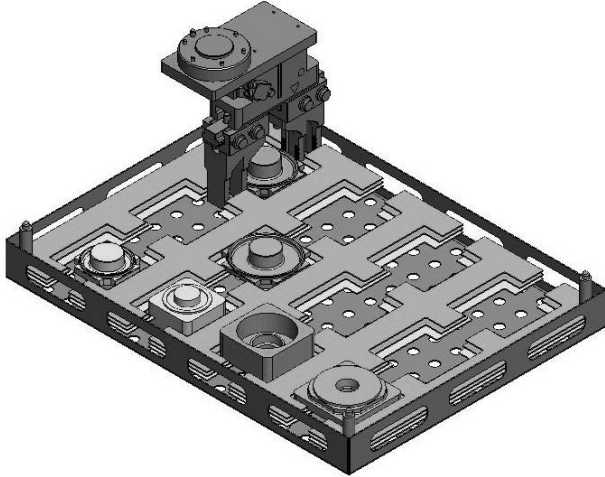

Item no. 201403

Workpiece Carrier WTB I

for light, small and high-precision components

Adapted for automated production

For high-precision and delicate components

Pick-up elements (metal or plastic) adapted to products to be carried

Made of steel, stainless steel, aluminium or combinations

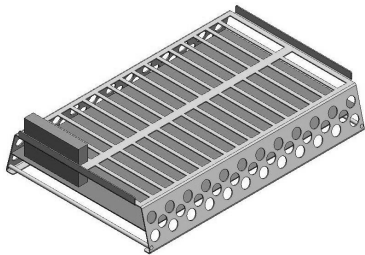

Item no. 201465

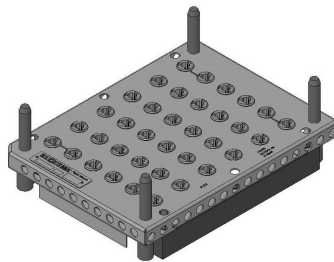

Item no. 146684



Item no. 147667

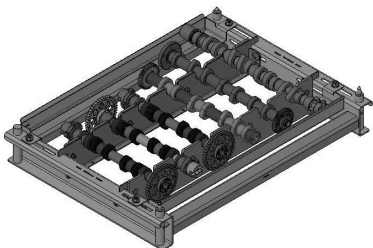

Item no. 139374

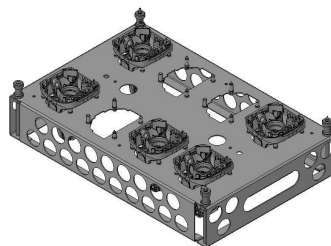

Item no. 137432

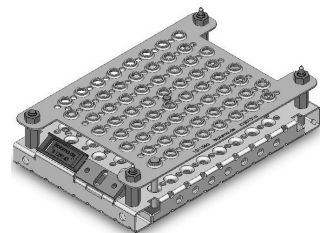

Item no. 131031

Due to the geometric shapes of the components / parts, the workpiece carriers are designed individually according to customer's requirements.

During the past 40 years, BLOKSMA has developed and produced more than 2.400 different kinds of workpiece carriers.

WORKPIECE CARRIERS

Workpiece Carrier WTB II

for light, small and high-precision
components

Adapted for automated production

For high-precision and delicate
components

Pick-up elements (metal or plastic)
adapted to products to be carried

Made of steel, stainless steel, aluminium
or combinations

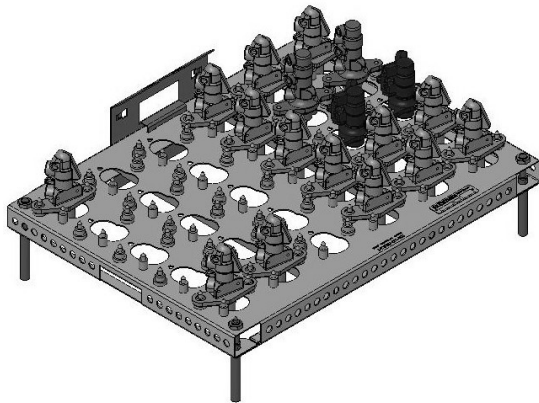

Item no. 130365

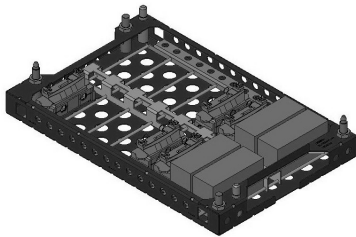

Item no. 130452

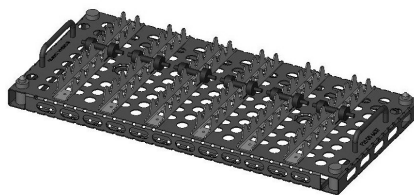

Item no. 124392

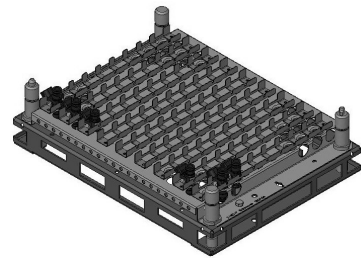

Item no. 132117

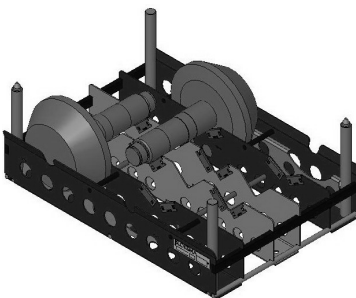

Item no. 127971

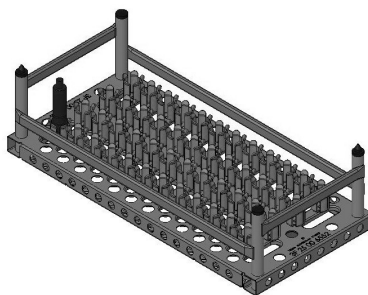

Item no. 138207

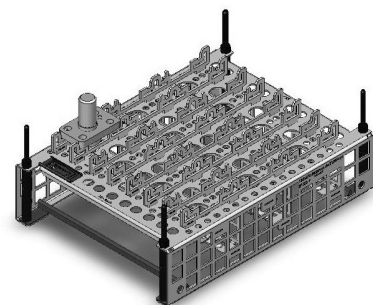

Item no. 129741

Due to the geometric shapes of the components / parts, the workpiece carriers are designed individually according to customer's requirements.

During the past 40 years, BLOKSMA has developed and produced more than 2.400 different kinds of workpiece carriers.